

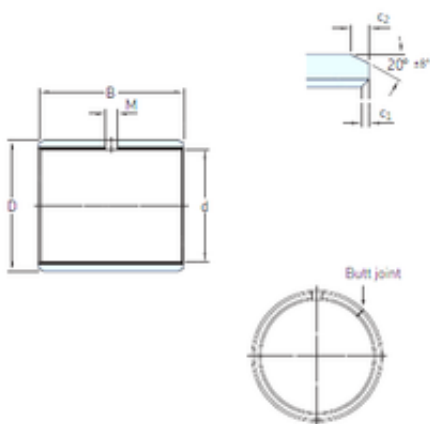

BEARING ITALIA S.P.A

100 mm x 105 mm x 30 mm skf PCM 10010530
M Plain bearings, Bushings



Bearing No. PCM 10010530 M

Size	100x105x30 mm
Bore Diameter	100 mm
Outer Diameter	105 mm
Width	30 mm
d	100 mm
D	105 mm
B	30 mm
c1 min	0,2 mm
c2 min	1,2 mm
M	6 mm
Weight	0,17 Kg
Basic dynamic load rating (C)	345 kN
c ₁ min.	0.2 mm
c ₁ max.	1 mm
c ₂ min.	1.2 mm
c ₂ max.	2.4 mm
± 8	20 °
Tolerance shaft	h8
Tolerance housing	H7
Basic dynamic load rating - radial direction C	345 kN
Basic static load rating - radial direction C ₀	720 kN
Specific dynamic load factor K	120 N/mm ²
Specific static load factor K ₀	250 N/mm ²

PCM 10010530 M Bearing 2D drawings and 3D CAD models



BEARING ITALIA S.P.A

Factor depending on material and bearing type K_M	1900
Permissible sliding velocity v min.	0 m/s
Permissible sliding velocity v max.	2.5 m/s
Coefficient of friction μ min.	0.02
Coefficient of friction μ max.	0.2
Mass bushing	0.17 kg