

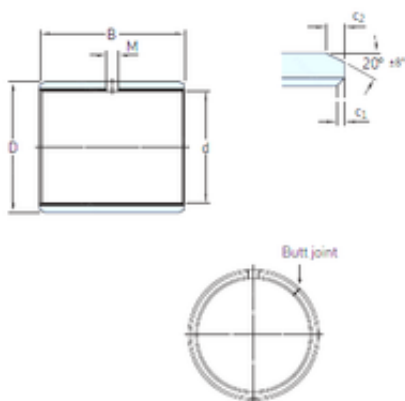

BEARING ITALIA S.P.A

88,9 mm x 93,663 mm x 63,5 mm skf PCZ 5640
M Plain bearings, Bushings



Bearing No. PCZ 5640 M

Size	88.9x93.663x63.5 mm
Bore Diameter	88,9 mm
Outer Diameter	93,663 mm
Width	63,5 mm
d	88,9 mm
D	93,663 mm
B	63,5 mm
c1 min	0,2 mm
c2 min	1,2 mm
M	6 mm
Weight	0,3 Kg
Basic dynamic load rating (C)	670 kN
c ₁ min.	0.2 mm
c ₁ max.	1 mm
c ₂ min.	1.2 mm
c ₂ max.	2.4 mm
± 8	20 °
Shaft diameter range min.	88.448 mm
Shaft diameter range max.	88.504 mm
Housing bore range min.	93.662 mm
Housing bore range max.	93.698 mm
Basic dynamic load rating - radial direction C	670 kN
Basic static load rating - radial direction C ₀	1370 kN

PCZ 5640 M Bearing 2D drawings and 3D CAD models



BEARING ITALIA S.P.A

Specific dynamic load factor K	120 N/mm ²
Specific static load factor K ₀	250 N/mm ²
Factor depending on material and bearing type K _M	1900
Permissible sliding velocity v min.	0 m/s
Permissible sliding velocity v max.	2.5 m/s
Coefficient of friction μ min.	0.02
Coefficient of friction μ max.	0.2
Mass bushing	0.3 kg